

WAC LIGHTING

Low Voltage Multiple Spots 2 Light LED MR16 Trim

Model	Finish
MT-216LED	WT White
MT-216LEDTL	WT/WT White/White

Example: **MT-216LED-WT/WT**

DESCRIPTION

Low Voltage Multiple Spots are ideal for perimeter lighting applications in smaller scale retail, commercial and hospitality environments. Square single light gimbal ring style adjustable recessed fixture, available with flanged trim or Invisible Trim, designed to sit flush with the ceiling for a clean architectural look. Housing, trim, and lamp are sold separately.

FEATURES

- Trim version has a 1/4" low profile, Invisible Trim sits flush to ceiling
- The supplied clear glass lens can be replaced by a variety of lenses or accessories
- 5 year warranty

SPECIFICATIONS

Construction:	Stamped metal trim
Power:	14W
Light Source:	LED MR16 (Included)
Cut Out:	Trimless : 5 5/8" x 9 5/8", Trim : 5 3/16" x 9 1/8"
Finish:	Electrostatically Powder Coated White, White/White
Standards:	UL, cUL, Damp Location Listed

Fixture Type: _____

Catalog Number: _____

Project: _____

Location: _____



FINISHES



LINE DRAWING

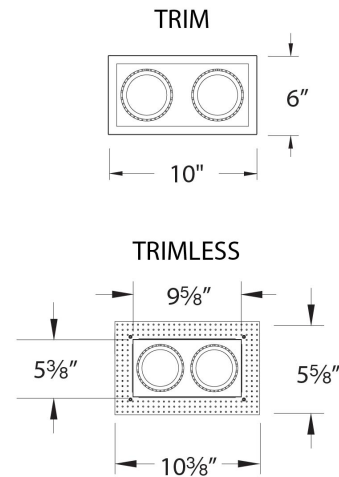

Fixture Type: _____

Catalog Number: _____







Project: _____

Location: _____

Low Voltage Multiple Spots

2 Light LED MR16 Trim

ACCESSORIES

	<i>Model</i>	<i>Description</i>	<i>Finish</i>
	LENS-16-AMB LENS-16-BLU LENS-16-GRN LENS-16-RED	<i>Colored Lens</i> <i>Colored Lens</i> <i>Colored Lens</i> <i>Colored Lens</i>	<i>Amber</i> <i>Blue</i> <i>Green</i> <i>Red</i>
	LENS-16-FR	<i>Clear/Frosted Lens</i>	<i>Frosted</i>
	LENS-16-SPR	<i>Spread Lens</i>	<i>Spread Lens</i>
	LENS-16-UVF	<i>UV Filter lens</i>	<i>Clear</i>
	LENS-16-BEL	<i>Beam Elongating Lens</i>	<i>Beam Elongating</i>
	LENS-16-HCL	<i>Honeycomb Louver</i>	<i>Black</i>

WAC LIGHTING

Low Voltage Multiple Spots 2 Light Housing

Model & Product

MT-216HS Low Voltage Multiple Two Light Non-IC Housing

Example: **MT-216HS**

DESCRIPTION

Low Voltage Multiple Spots are ideal for perimeter lighting applications in smaller scale retail, commercial and hospitality environments. Square single light gimbal ring style adjustable recessed fixture, available with flanged trim or Invisible Trim, designed to sit flush with the ceiling for a clean architectural look. Housing, trim, and lamp are sold separately.

FEATURES

- Electronic short circuit and overload protection with automatic reset
- Soft start to prolong lamp life
- Transformer concealed within the fixture
- 5 year warranty

SPECIFICATIONS

Construction:	Aluminum hardware with mouth blown etched glass diffuser
Input:	120 VAC, 50/60Hz
Dimming:	ELV: 100-10%
Light Source:	Halogen or LED MR16
Mounting:	Supplied with hanger bars, adjustable from 15"-24 1/2" to accommodate various joist construction and grid sizes
Ceiling Thickness:	1/2" - 1"
Standards:	UL, cUL, Damp Location Listed, Non IC

Fixture Type: _____

Catalog Number: _____

Project: _____

Location: _____



LINE DRAWING

